

Molteni & C

WHEN — RODOLFO DORDONI 2009

1—
2



A structural design incorporates the lines of the Wish bed and the Who chairs. When, a series of small tables in solid wood with double round top, is available in various finishes: wood, glass and marble. Three versions with different height and top diameter, suitable for the bedroom as well as the living room. The inlaid wood table top matches a lower top made out of smoked glass, marble or the same wood.

DATASHEET

REGISTERED
DESIGN

IX.2018

FINISHES

STRUCTURE AND WOODS TOP FINISHES

eucalyptus - grey oak - graphite oak - black oak

LOWER SHELF MARBLE FINISHES

white Carrara - emperador dark - black marquina

TECHNICAL INFORMATION

STRUCTURE

In solid Oak (Quercus). For the Eucalyptus version this is in American walnut (Juglans nigra) stained. Supporting feet in felt.

WOODEN OCCASIONAL TABLE TOP (UPPER OR LOWER) / DRAWER COVER

Panel in medium density fibre covered in sliced Oak wood or Eucalyptus (Eucalyptus globulus).

STRUCTURE AND DRAWER FRONT

Curved veneer wood covered in sliced Oak or Eucalyptus.

CRYSTAL LOWER TOP

Tempered 12 mm crystal, shiny, bevelled, smoked.

MARBLE LOWER TOP

Marble in Range finishes with anti-stain, water-repellent treatments.

REINFORCEMENT SUPPORT

4 mm chromed sheet steel.

INSIDE EDGES FOR DRAWER

In solid Oak or Eucalyptus stained.

INSIDE BOTTOM FOR DRAWER

Wooden particleboard panel faced with sliced Oak. For the Eucalyptus version this is in Oak stained.

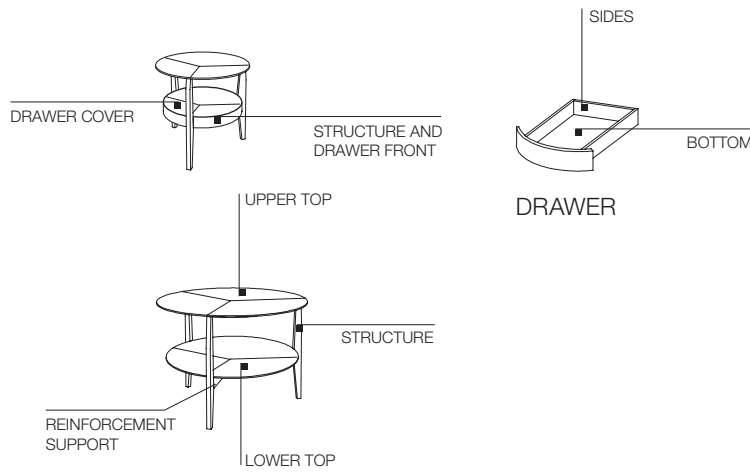

DIMENSIONS

small table

WTW1

lower shelf smoked glass lower shelf marble lower shelf wood



Ø 45
Ø 17 3/4"



small table

WTW2

lower shelf smoked glass lower shelf marble lower shelf wood



Ø 50
Ø 19 3/4"



small table with drawer

WTCW2

lower shelf smoked glass lower shelf marble lower shelf wood



Ø 50
Ø 19 3/4"



DATASHEET

REGISTERED
DESIGN

IX.2018

Molteni & C

**FINISHES
MOLTENI&C
RANGE**
IX.2018

	MATT LACQUER	GLOSSY LACQUER	COLOURED GLASS	ETCHED COLOURED GLASS	CARTAPAGLIA LACQUERED only Gliss Master	STOPSOL GLASS TRANSPARENT STOPSOL GLASS
CHALK WHITE	•	•	•	•	•	
PEARL	•	•	•	•	•	
SILICA	•	•	•	•	•	
SAND	•	•	•	•	•	
DOVE GREY	•	•	•	•	•	
PLATINUM	•	•	•	•	•	
DUNE	•	•	•	•	•	
CLAY	•	•	•	•	•	
DOLOMITE GREY	•	•	•	•	•	
COPPER	•	•	•	•	•	
RUST	•	•	•	•	•	
RUBY	•	•	•	•	•	
CARAMEL	•	•	•	•	•	
MOKA	•	•	•	•	•	
MUSTARD	•	•	•	•	•	
LIGHT BLUE GREY	•	•	•	•	•	
PEWTER COLOUR	•	•	•	•	•	
ANTHRACITE	•	•	•	•	•	
BLACK	•	•	•	•	•	
STOPSOL						•
LESSLESS RED	•					
	only matt lacquer					

The finishes shown are indicative and refer to the entire production range. We recommend that you consult the "Colour Range" samples which show the complete range of finishes, including those not shown here. Molteni&C reserves the right to modify the range without warning.

WOODS

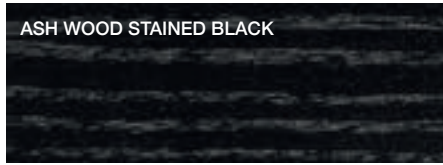
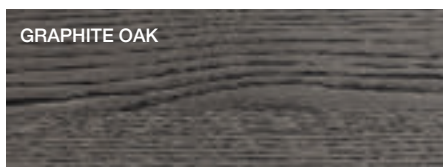
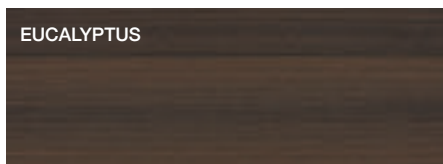

MARBLES

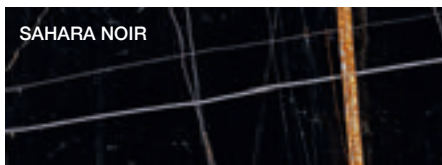
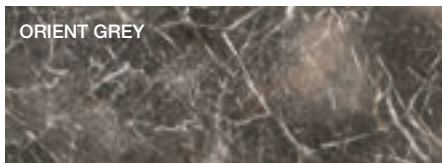
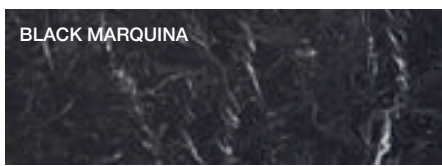
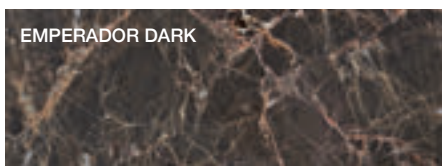
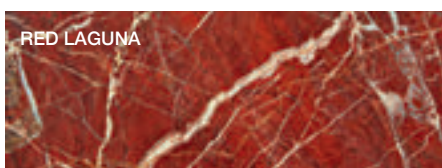
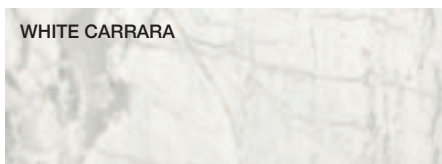

METAL PARTS

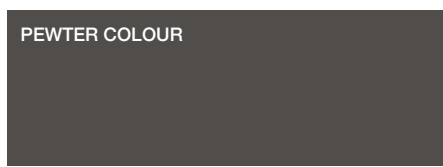
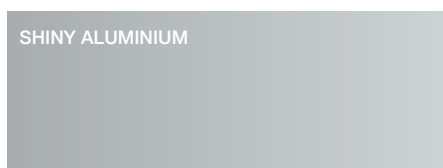

MELAMINE FRONT
GLISS MASTER

CARTAPAGLIA WHITE

CARTAPAGLIA ANTHRACITE

CARTAPAGLIA SILICA

GRAFFIATO SILICA

GRAFFIATO BRONZE

SILK DOVE GREY

SILK SILICA

SILK CHALK WHITE

MELAMINE STRUCTURE
GLISS MASTER

WHITE SHANTUNG

GREY SHANTUNG

MELAMINE STRUCTURE
GLISS MASTER, MASTER DRESSING,
GLISS WALK-IN

SILVER CEMBRAN

LARIX DARK

MELAMINE STRUCTURE
GLISS MASTER, MASTER DRESSING

WHITE

ECO SKIN

IVORY

HEMP

MINK

DARK BROWN

GREY

FINE GRAIN

FINE GRAIN