



■ Vers. 223+291+291+223



■ Vers. 072+045+291+045+291+225



■ Vers. 221+291+032+291+291+223



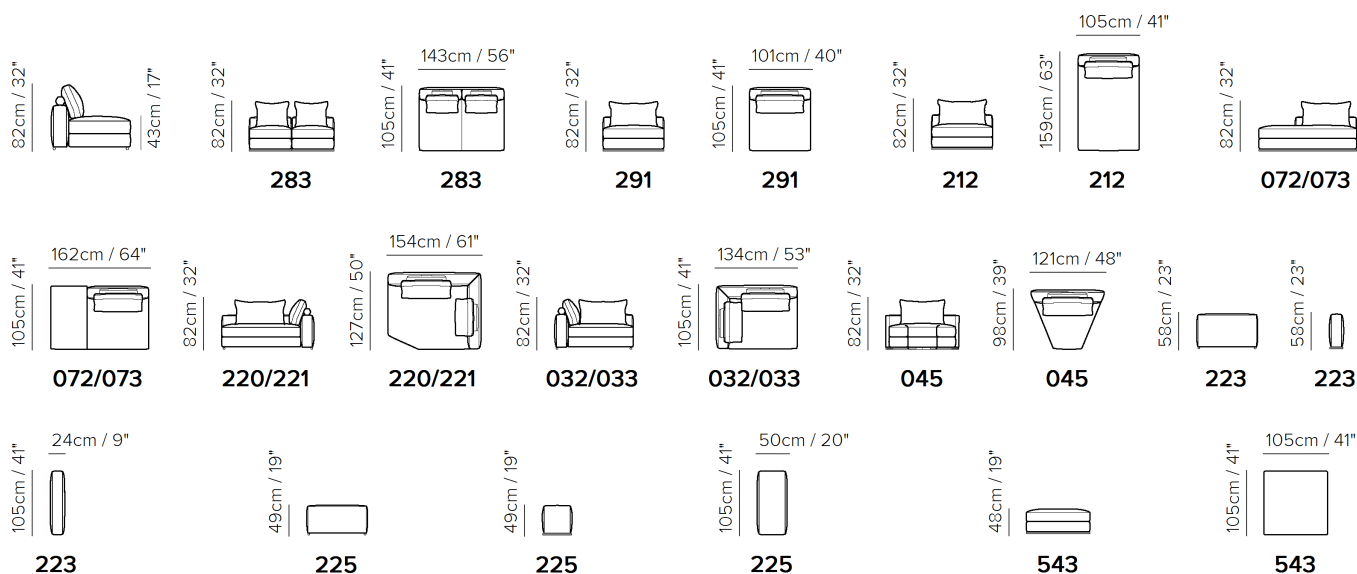

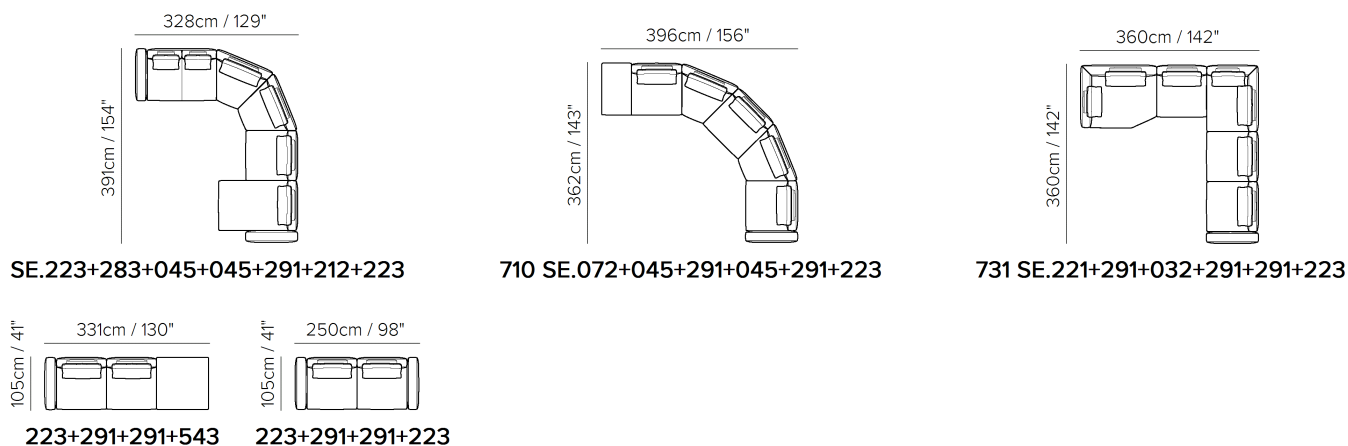

SCHEMATICS



COMPOSITION EXAMPLES



TECHNICAL INFORMATION

	COVERING	Leather <input checked="" type="checkbox"/>	Soft Cover <input checked="" type="checkbox"/>			
	LEGS	Wood <input type="checkbox"/>	Metal <input type="checkbox"/>	Plastic <input type="checkbox"/>	Castors <input type="checkbox"/>	Upholstered <input type="checkbox"/>
	FILLING	Arms	<input type="checkbox"/> Fiber <input type="checkbox"/> Foam <input type="checkbox"/> Feather/Fiber Mix <input type="checkbox"/> Feather	Seat cushion	<input type="checkbox"/> Fiber <input type="checkbox"/> Foam <input type="checkbox"/> Feather/Fiber Mix <input type="checkbox"/> Feather	Back cushion <input type="checkbox"/> Fiber <input type="checkbox"/> Foam <input type="checkbox"/> Feather/Fiber Mix <input type="checkbox"/> Feather
	COMFORT	Firm Comfort <input type="checkbox"/>	Standard Comfort <input checked="" type="checkbox"/>			
	FUNCTION	Bed <input type="checkbox"/>	Electric motion <input type="checkbox"/>	Motion <input type="checkbox"/>	Recliner <input type="checkbox"/>	Sliding <input type="checkbox"/>
	OPTIONS	Removable <input type="checkbox"/>	Nails <input type="checkbox"/>	Contrast Stitching <input type="checkbox"/>		

NOTES

- Designer: Maurizio Manzoni
- Modular seats with retractable hooks and fully upholstered sides. Armrests are separate modules that separate from the seat and are available in two different widths and heights to fit your desired comfort and taste.
- Inspired by the Federician castles and cathedrals that dominate Apulia, Dominio is designed to be an important and reassuring presence in the home.
- Each seat is enriched on the front and back, by a tubular steel foot with hexagonal section delivered to the home of the final consumer already assembled. The foot of the armrest is the only element that connects with the tubular base of the other seats. The remaining versions do not connect, but are simply brought together.
- To allow modularity, the single elements can be put together thanks to the rubber stops under the legs.
- EUCAFEEL® is the innovative solution offers many benefits: Best moisture regulation, ideal warmth control, first class pressure relief and high elasticity. The distinctive EUCAFEEL high density polyurethane foam, thanks to its specially developed formulation, has maximum breathability and maximum comfort.
- Metal feet are available in two different finishes: 79 matt black or 89 glossy silver.

NOTES
